

HEADLIGHT (WITHOUT DRL) (4SD)

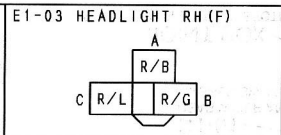

HEADLIGHT (WITHOUT DRL) (5HB)

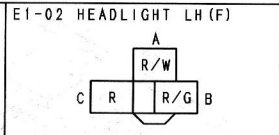
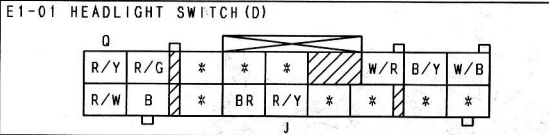
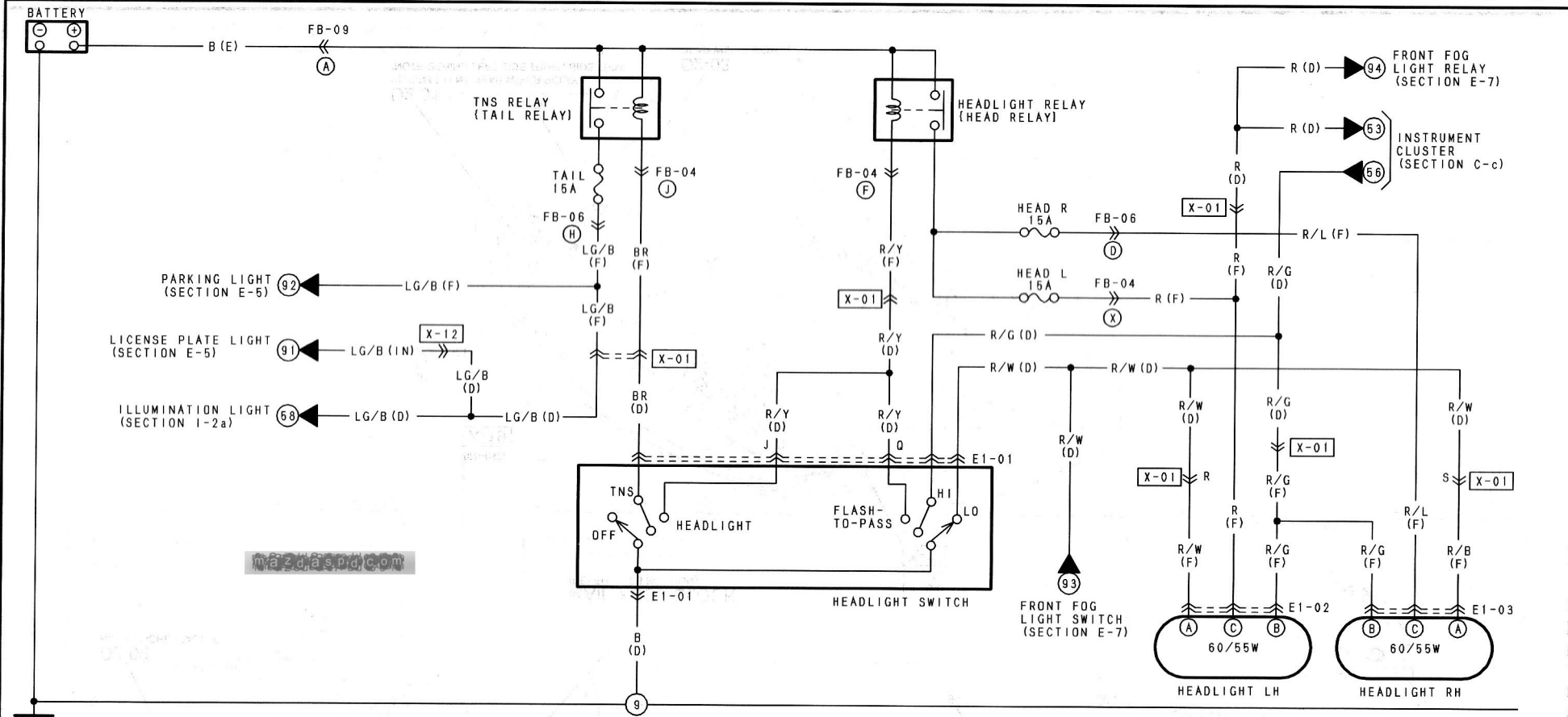
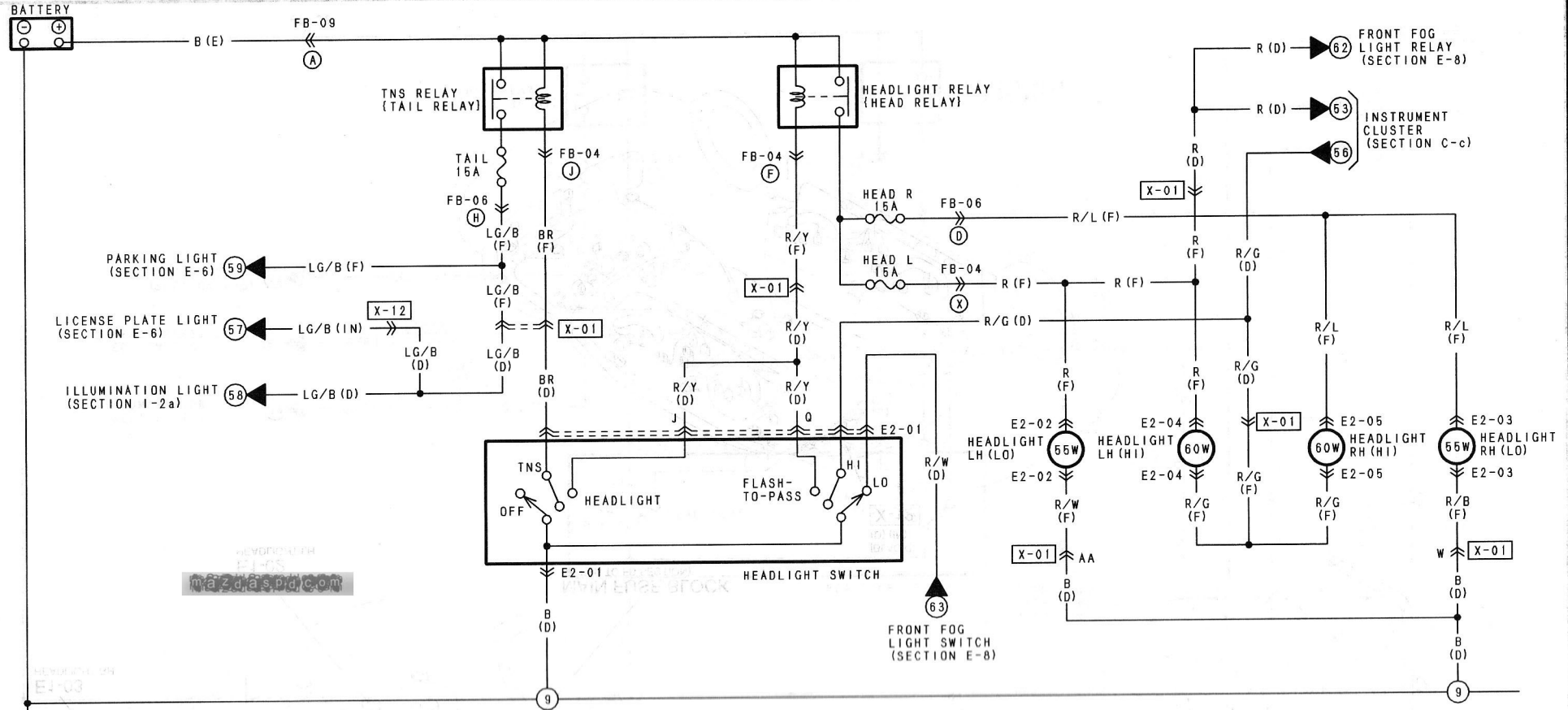

777

E2-01 HEADLIGHT SWITCH (D)

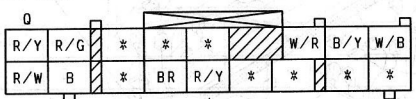

E2-02 HEADLIGHT LH (LO) (F)



E2-03 HEADLIGHT RH (LO) (F)

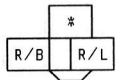

E2-04 HEADLIGHT LH (HI) (F)

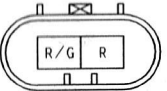

E2-05 HEADLIGHT RH (HI) (F)

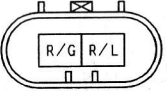

HEADLIGHT (WITH DRL) (4SD)

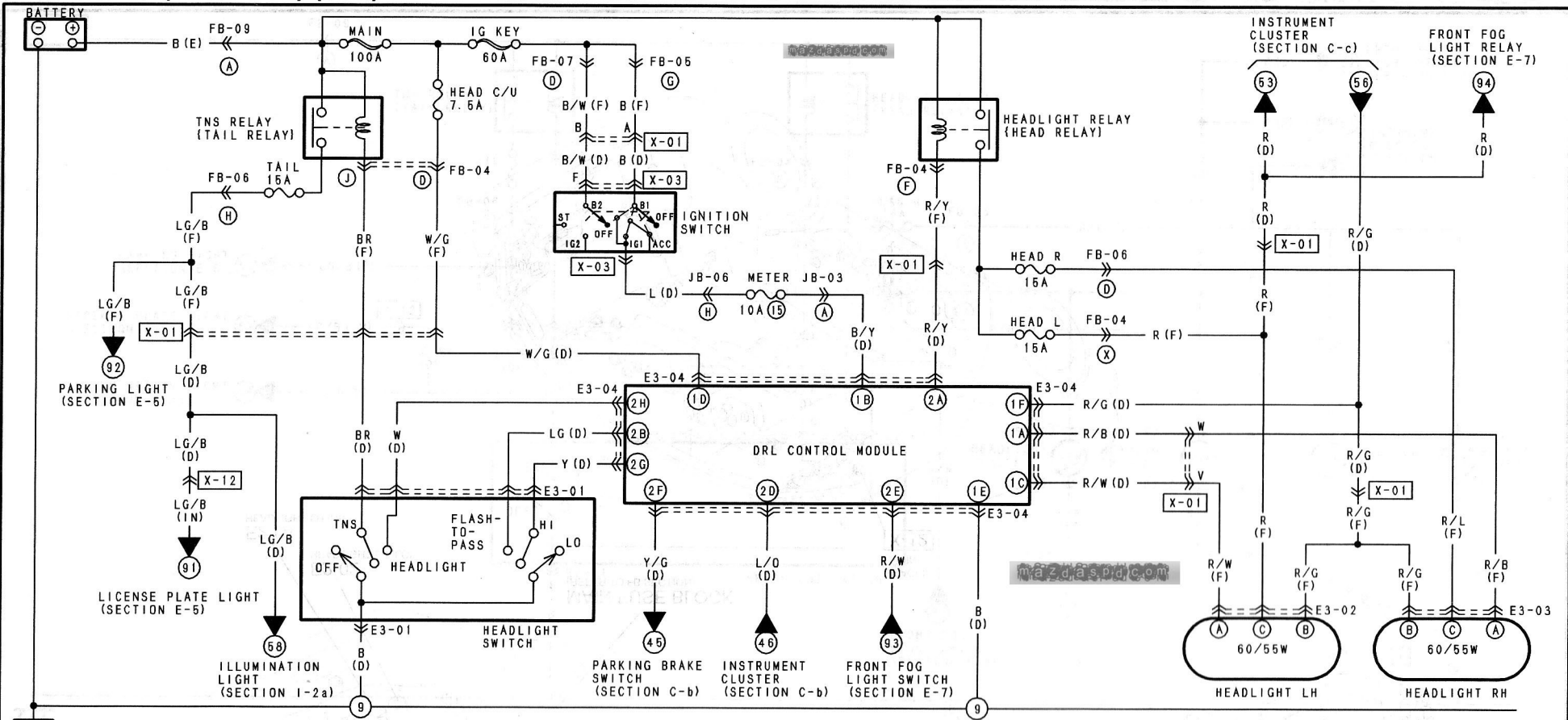

E3-01 HEADLIGHT SWITCH (D)

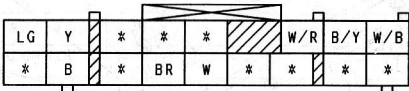

E3-02 HEADLIGHT LH (F)

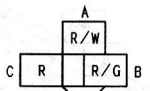

E3-03 HEADLIGHT RH (F)

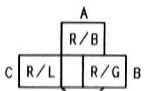

E3-04 DRL CONTROL MODULE (D)

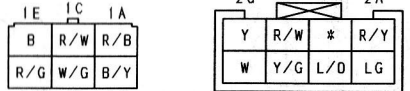

HEADLIGHT (WITH DRL) (5HB)

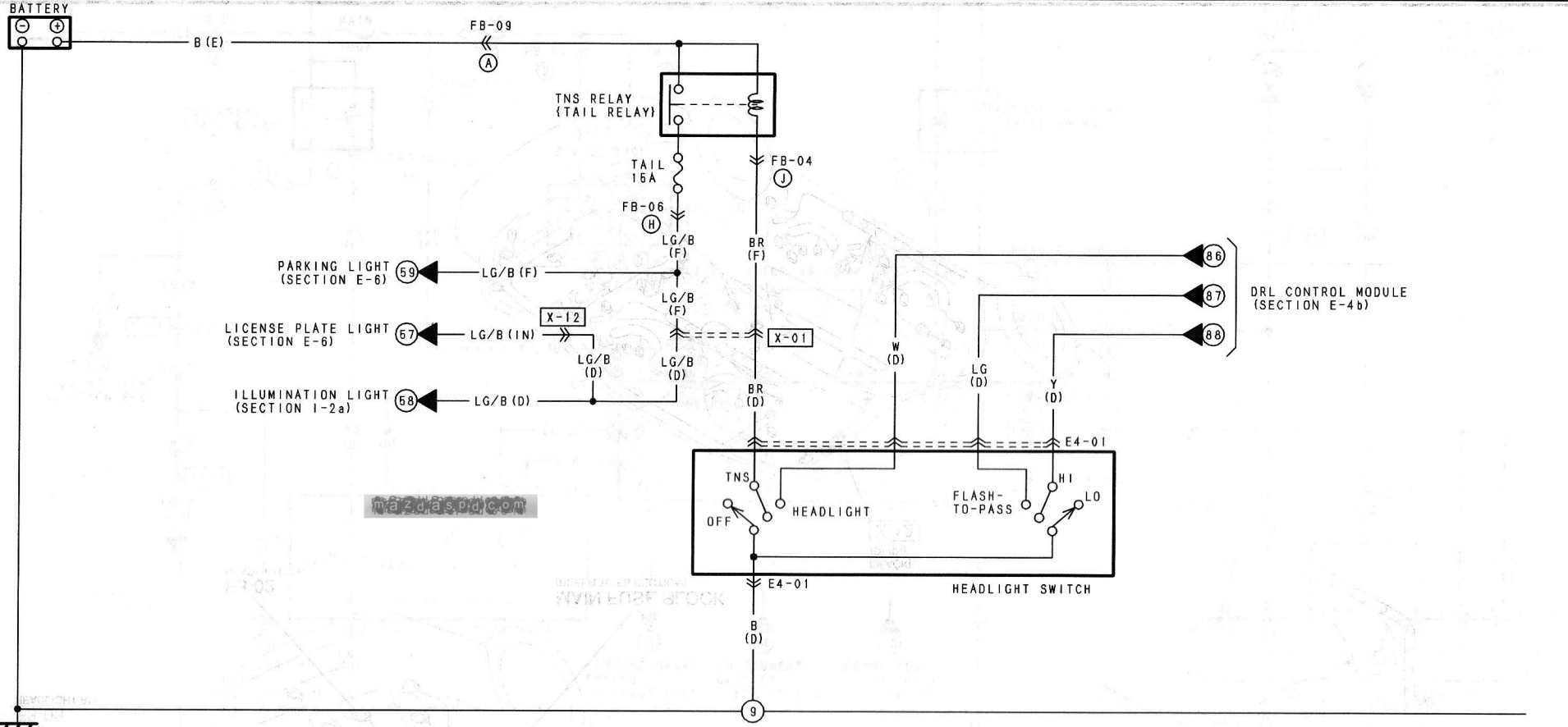

TTT

E4-01 HEADLIGHT SWITCH (D)

LG	Y	*	*	*	W/R	B/Y	W/B
*	B	*	BR	W	*	*	*

HEADLIGHT (WITH DRL) (5HB)

E-4b

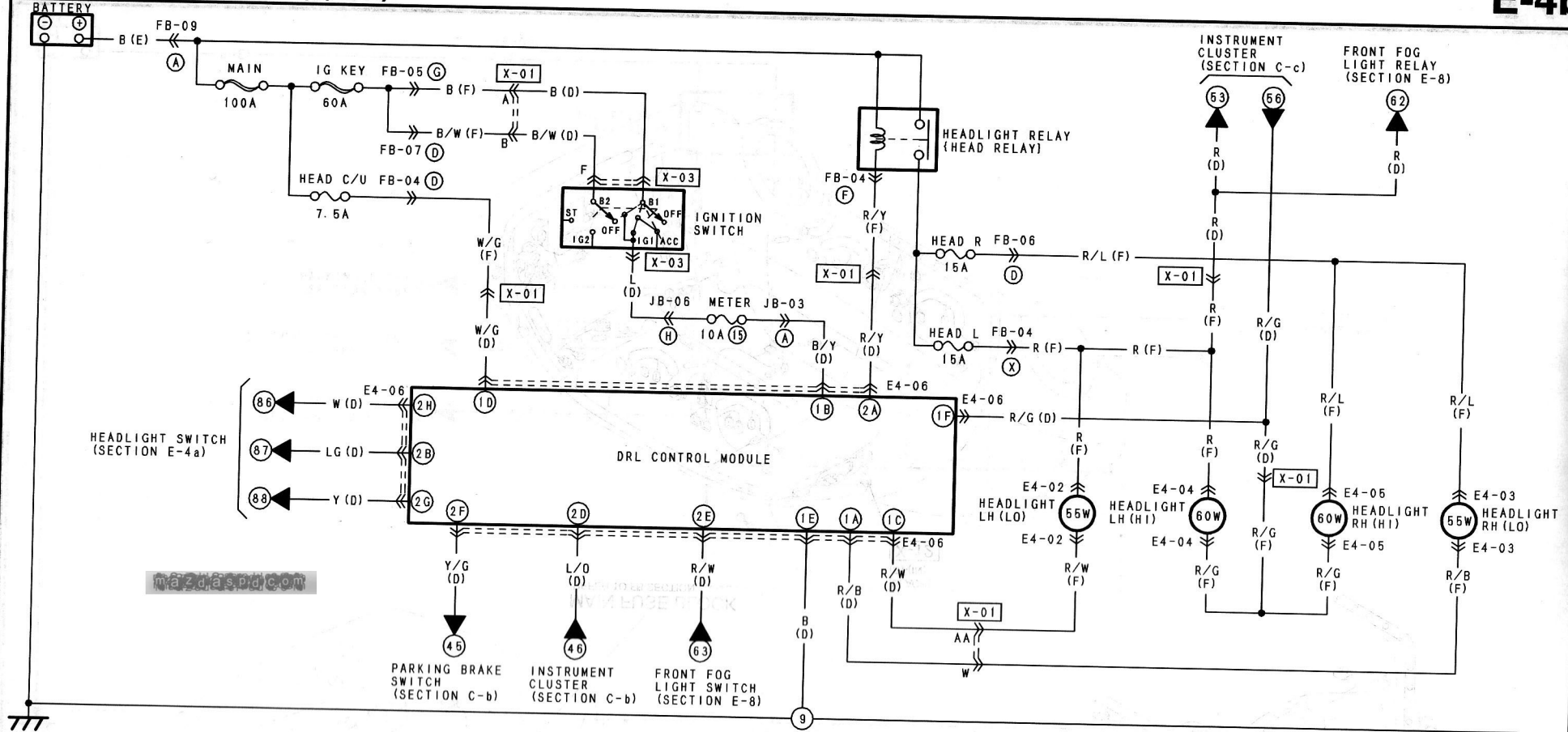

E4-02 HEADLIGHT LH (LO) (F)

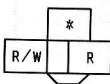

E4-03 HEADLIGHT RH (LO) (F)

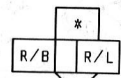

E4-04 HEADLIGHT LH (HI) (F)

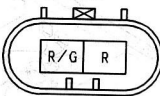

E4-05 HEADLIGHT RH (HI) (F)

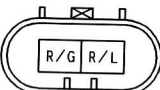

E4-06 DRL CONTROL MODULE (D)

